

3 601 B18 1K0

Stand } 13-07  
Issue } 14-02-07

Fig./Abb. 1

\* Montage  
assembly  
position de montage  
position de montage

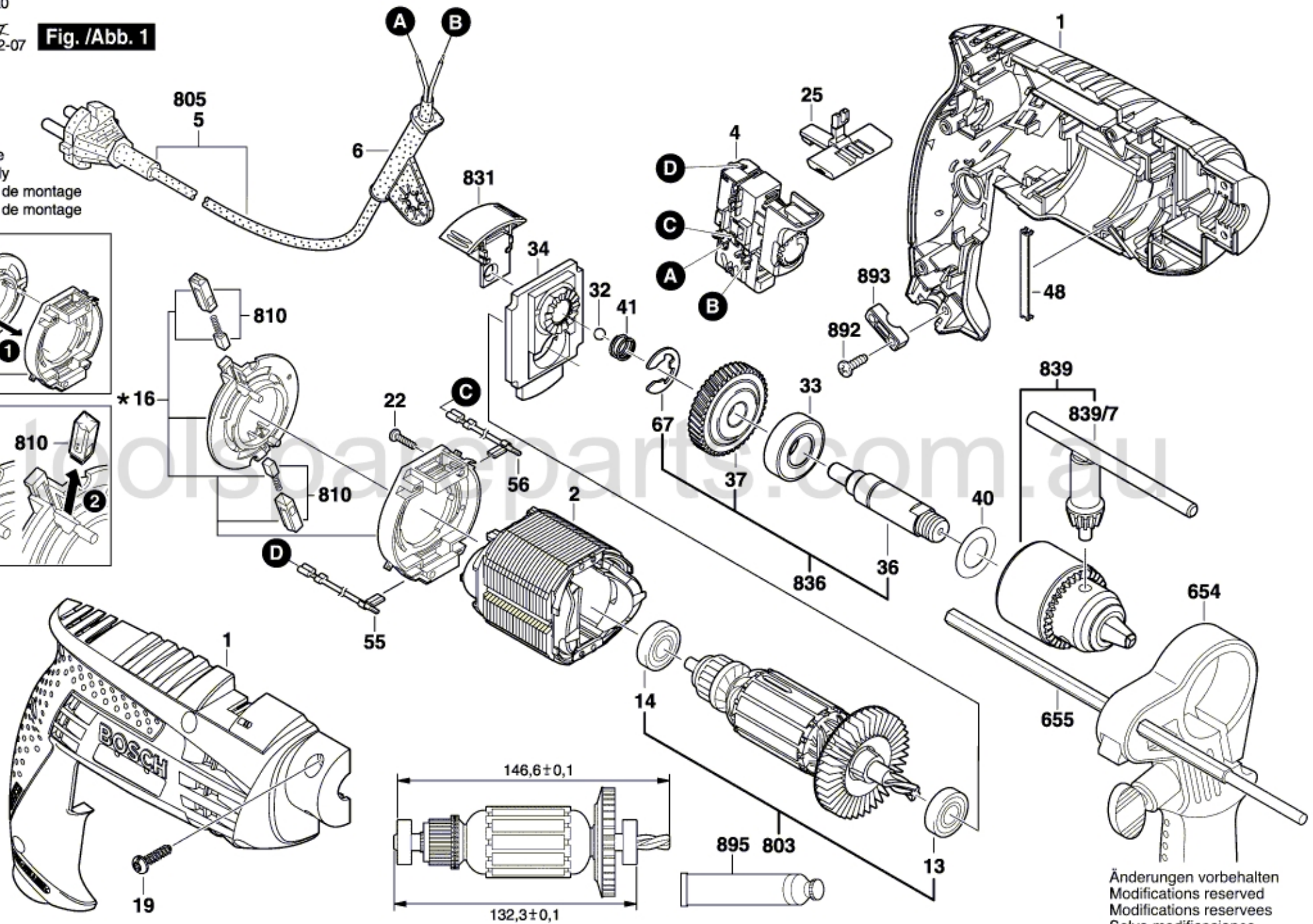
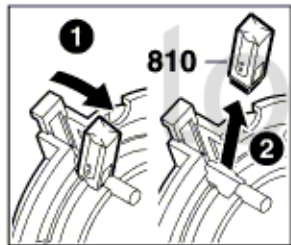
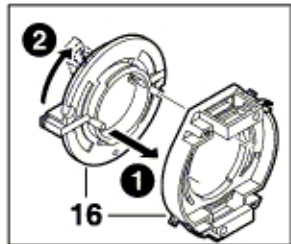

Änderungen vorbehalten  
Modifications reserved  
Modifications reserves  
Salvo modificaciones